

Ceiling LED Chandelier

CH14356
INSTALLATION SHEET

START FROM HERE

- Make sure power is completely off at the fuse box.
- Have your fixture installed by a qualified licensed electrician
- Prepare everything in a clear area.
- Wear gloves at all times during this installation.
- Read instructions carefully before you start assembly.
- Keep this instruction sheet for future reference.

Technical Support: 1-855-855-8926

Please Note:

- This Kuzco LED fixture comes with pre-wired LED module(s).
- Unless instructed to do so, please do not touch any part of the LED module(s) as any unnecessary contact with the module could cause permanent damage.
- For dimming, an ELV (Electronic Low Voltage) or TRIAC type of dimmer is required.
- 120V input

1. Remove the fixture from its original packaging.
2. Secure the mounting plate (1c) to the junction box (1a) with junction box screws (1e) provided in the hardware package.
3. Remove the driver cover (2d) from the canopy (2a) by turning counter clockwise.
4. Pull aircraft cable (4a) into canopy (2a) and loop it through canopy frame and secure aircraft cable (4a) in wire gripper (4b) with screws (4c) (Illustration 2).
5. Determine hanging height of fixture by securing rods (2e) to canopy (2a) and fixture hub (3a) after feeding fixture wires (LED+ and LED-) through rods.
6. Make proper electrical connections between LED and DC driver, LED- Negative, LED+ Positive using wago connector (2g) provided (See Illustration 1 and refer to diagram on driver).
7. Make proper electrical connections (black to hot "L", white to neutral "N", ground to "GND") with wire nuts (1b) provided in hardware package
8. Attach canopy (2a) to mounting plate (1c) with canopy screws (2b) and close canopy with driver cover (2d) by turning clockwise.
9. Attach LED spoke (3b) to fixture hub (3a) and secure with set screws (3e) (See Illustration 3). Attach connector from LED spoke (3b) to fixture hub (3a) connector. Slide diffuser (3c) to close LED spoke (3b) and secure with end-cap (3d) (use a rubber mallet if necessary, not provided).

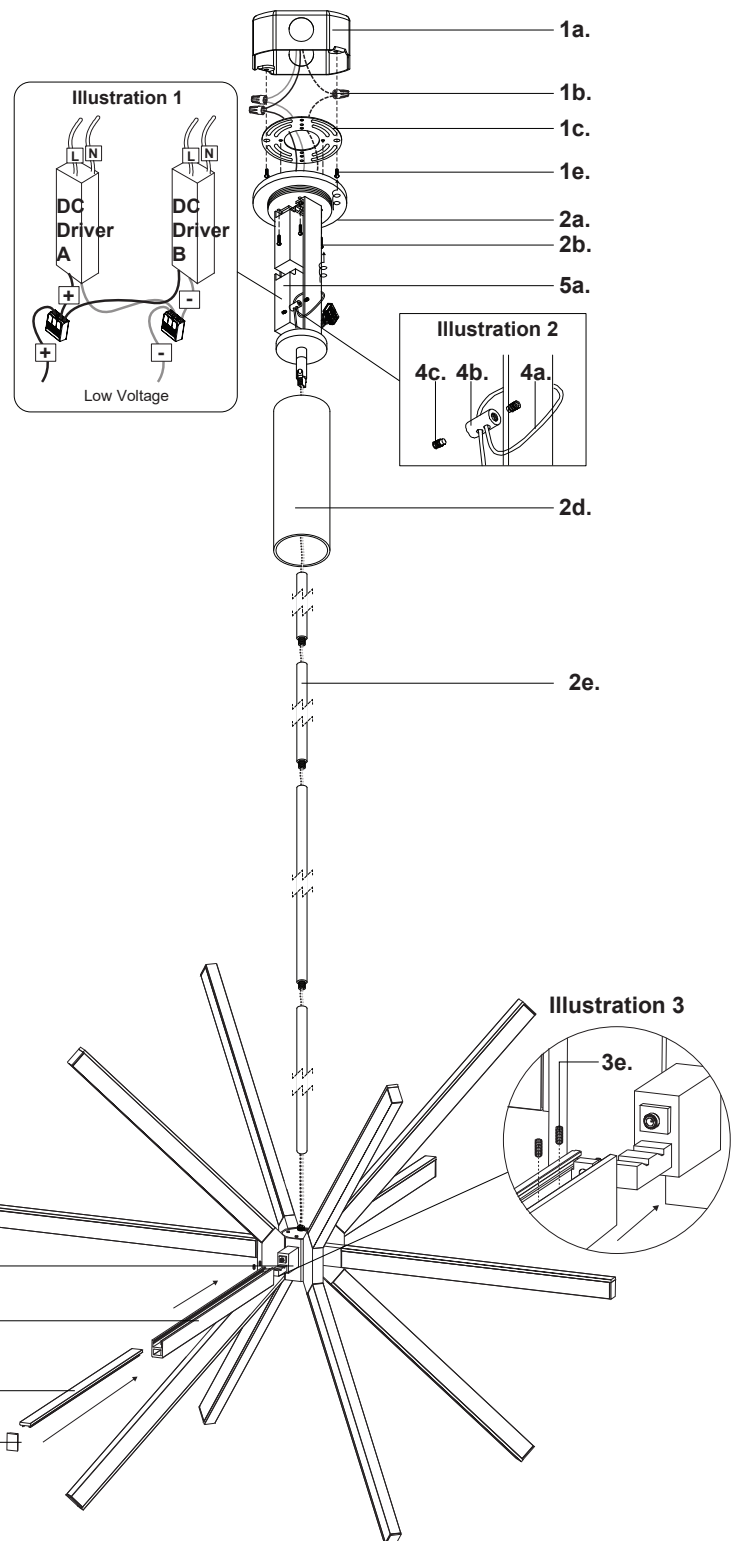

KUZCO

19054 28th Avenue Surrey, BC Canada V3Z 6M3
T: 604 538 7162 TF: 1-855 85 KUZCO F: 604 538 7196
W: kuzcolighting.com
20220816